

## *Voltage Protection Relay*



### Features

- Low-set undervoltage stage with definite time or inverse time
- High-set undervoltage stage with definite time
- Low-set overvoltage stage with definite time or inverse time
- High-set overvoltage stage with definite time
- Negative sequence overvoltage protection
- Neutral displacement/ residual overvoltage protection
- Multi-function isolated digital input
- Fault data and event code recording
- Five programmable voltage-free output contacts
- Isolated RS485 Modbus-RTU communication

<b>Table of Contents</b>	<b>Page</b>
1. Introduction	2
2. Description of Operation	3
3. Display	12
4. Key Button Input	22
5. Programming	24
6. Soft Switches	27
7. Connection Diagram & Terminal Connection	52
8. Case Dimension	58
9. Technical Data	59
10. Test and Standards	61
11. Appendix A	62
12. Appendix B	63
13. Appendix C	64

For continuous product development, we reserve the right to supply equipment which may vary from that described in this manual.

## ***1. Introduction***

The MU2300 voltage protection relay is a microprocessor based numerical relay intended for the voltage protection in electrical distribution network. It can also be used for generators, motors and transformer protection.

A fully digital user interface with bright seven-segment display and indicators provides a very user friendly access to all the measurements, user parameters and records.

MU2300 uses a digital filter to extract the fundamental voltage waveforms for the three phases, phase-to-phase voltage or phase-to-neutral voltage, for the operation of the protection elements. Such protection elements are undervoltage low-set and high-set; overvoltage low-set and high-set; negative sequence overvoltage low-set; residual overvoltage low-set.

Besides being operated from the front panel of MU2300, this relay can also be accessed when connected to a networked system through its isolated RS485 Modbus-RTU communication interface.

## ***Features***

- Low-set undervoltage stage with definite-time or inverse time
- High-set undervoltage stage with definite-time
- Low-set overvoltage stage with definite-time or inverse time
- High-set overvoltage stage with definite-time
- Negative sequence overvoltage protection
- Neutral displacement/ residual overvoltage protection
- Multi-function isolated digital input
- Fault data and event code recording
- Five programmable voltage-free output contacts
- Isolated RS485 Modbus-RTU communication

## ***2. Description of Operation***

MU2300 is equipped with 3 accurate and independent voltage inputs connected to the voltage transformers of the object to be protected. It continuously monitors these voltage inputs' fundamental frequency components for the occurrence of faults. On detection of a fault, the relay will start and then operated the trip output which is connected to the circuit breaker or indicator. The phase-to-phase voltage, phase-to-neutral voltage, negative sequence voltage and the residual voltage, measured at the moment of tripping, will be recorded in the memories of the relay.

The relay has four different voltage transformer (VT) configurations. Depending on the configuration chosen, the input voltages can be phase-to-phase voltages or phase-to-neutral voltages. If the inputs are phase-to-phase voltages, the protection setting is based on the phase-to-phase voltages. However, if the configuration chosen is for phase-to-neutral input voltages, the protection setting will then be based on the phase-to-phase voltages and the derived phase-to-phase voltages are for measurements only.

### ***2.1 Undervoltage Elements (27)***

The MU2300 has two stages for undervoltage protection, namely the low-set undervoltage element and high-set undervoltage element.

When the voltage values fall below the set low-set undervoltage value, the low-set undervoltage element will start and deliver a start signal to the contact output (if assigned) and the front panel START indicator. After a pre-set delay time, determined by the user's selection between definite-time and inverse time characteristic, the undervoltage element delivers a trip signal to the contact output (if assigned) and the front panel TRIP indicator. Similarly, the high-set undervoltage element will start and then deliver a trip signal to the contact output (if assigned) and the front panel indicators if the voltage falls below the set high-set undervoltage value for duration longer than the high-set definite time.

The low-set and high-set elements can be selectively blocked by the digital input if the appropriate switch setting in Soft Switch 9A and Soft Switch 9B are set. The high-set stage can also be set out of operation by Soft Switch 8.

When the relay is first powered on without any input voltages connected to the VTs, the undervoltage elements are temporary disabled. The undervoltage elements will be activated once any of the input voltages exceeded 10V. To ensure that the undervoltage protection elements will not trip the relay when the voltage inputs are energised, the delay time should be set sufficiently long or the undervoltage elements are set to be temporary blocked by the digital input.

### ***2.1.1 Inverse time delay characteristic***

The inverse characteristic for undervoltage  $U_{<}$ , is defined by the following equation:

$$t = \left[ \frac{\text{TMS}}{\left| 1 - \frac{V}{V_s} \right|} \right]$$

where:

- t = operating time in seconds
- TMS = time multiplier setting
- V = applied input voltage
- V<sub>s</sub> = relay setting voltage

NOTE: this equation is valid for  $V_s > V$

## Undervoltage Characteristic

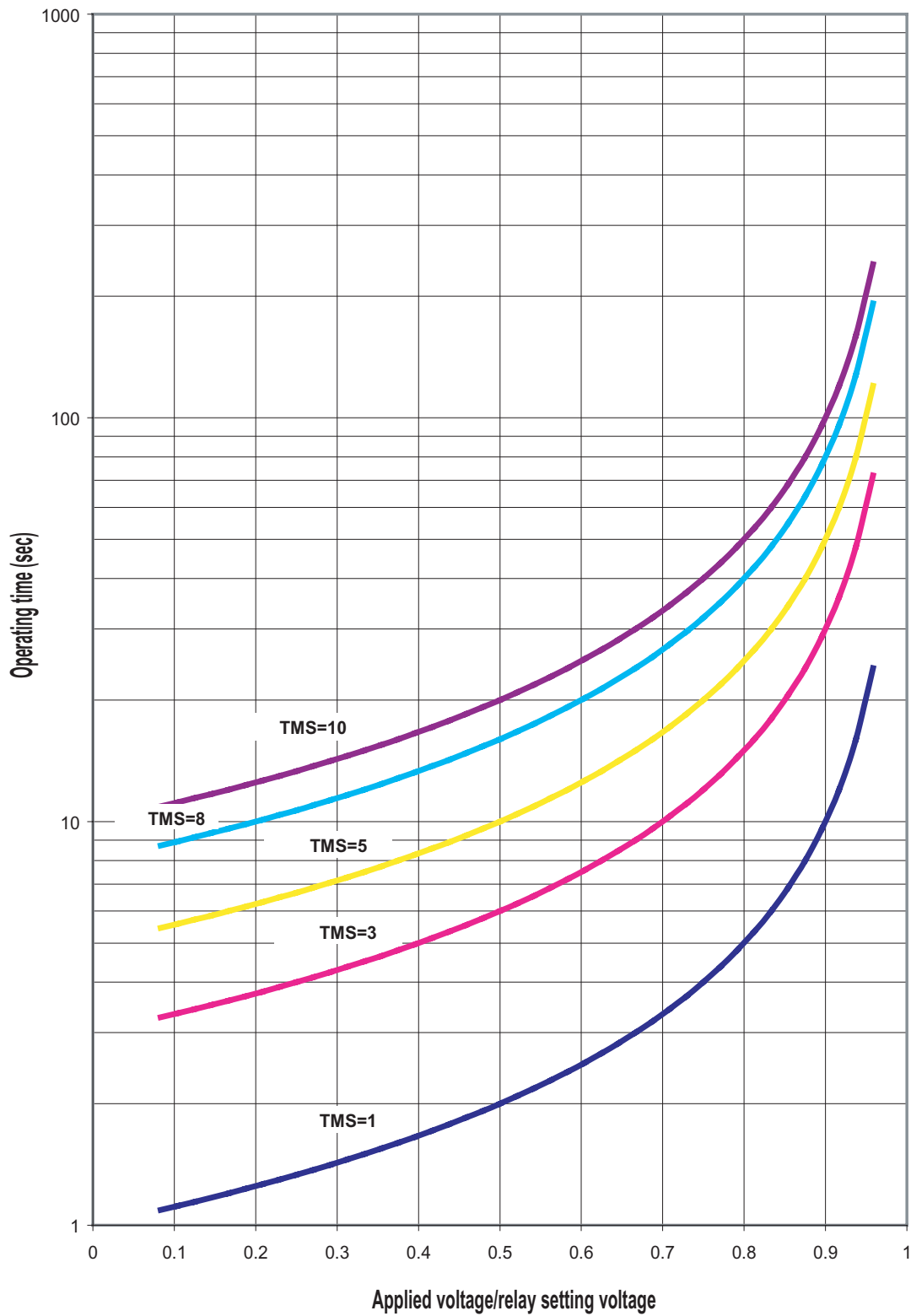

Figure 1: Inverse time curves for the undervoltage element “U<”

## 2.2 Overvoltage Elements (59)

The MU2300 has two stages for overvoltage protection, namely the low-set overvoltage element and high-set overvoltage element.

When the voltage values rise above the set low-set overvoltage value, the low-set overvoltage element will start and deliver a start signal to the contact output (if assigned) and the front panel START indicator. After a pre-set delay time, determined by the user's selection between definite-time and inverse time characteristic, the overvoltage element delivers a trip signal to the contact output (if assigned) and the front panel TRIP indicator. Similarly, the high-set overvoltage element will start and then deliver a trip signal to the contact output (if assigned) and the front panel indicators if the voltage values rise above the set high-set overvoltage value for duration longer than the high-set definite time.

The low-set and high-set elements can be selectively blocked by the digital input if the appropriate switch settings in Soft Switch 9A and Soft Switch 9B are set. The high-set stage can also be set out of operation by Soft Switch 8.

### 2.2.1 Inverse time delay characteristic

The inverse characteristic for overvoltage  $U >$ , is defined by the following equation:

$$t = \left[ \frac{\text{TMS}}{\left| \frac{V}{V_s} - 1 \right|} \right]$$

where:

- t = operating time in seconds
- TMS = time multiplier setting
- V = applied input voltage
- V<sub>s</sub> = relay setting voltage

NOTE: this equation is valid for  $V > V_s$

## Overvoltage Characteristic

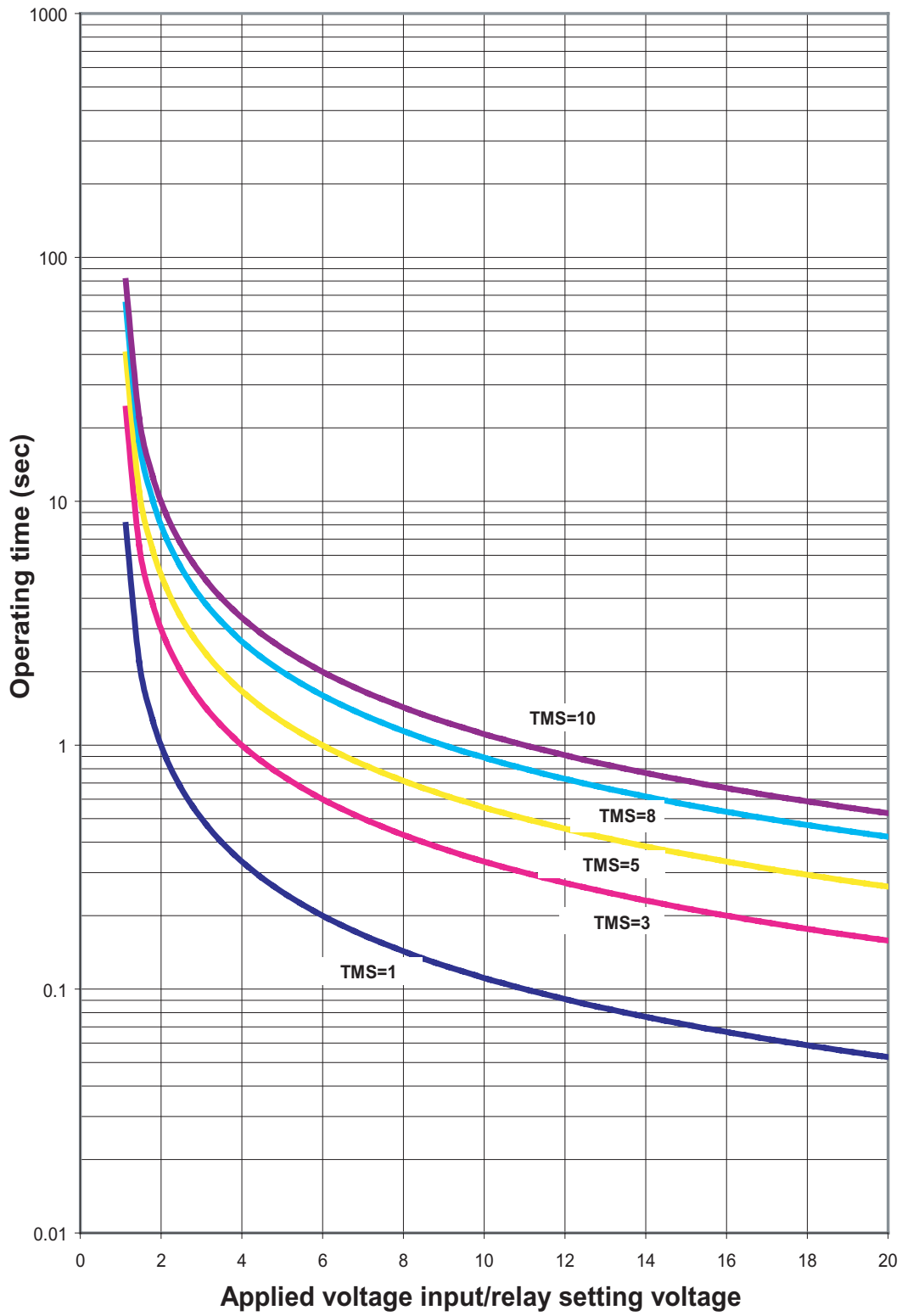

Figure 2: Inverse time curves for the overvoltage element “U>”



### 2.3 Negative Sequence Overvoltage Element (47)

For negative sequence overvoltage on MU2300, there is only low-set element. The negative sequence voltage is derived from the three phase-to-neutral voltages measured from the voltage inputs if the relay is configured in Soft Switch A to measure the phase-to-neutral voltages. If the relay is configured in Soft Switch A to measure the phase-to-phase voltages, the negative sequence voltage is derived from the phase-to-phase voltage.

When the negative sequence voltage value rises above the set low-set negative sequence value, the negative sequence low-set overvoltage element will start and deliver a start signal to the contact output (if assigned) and the front panel START indicator. After a pre-set delay time determined by the user's selection between definite-time and inverse time the negative sequence overvoltage element delivers a trip signal to the contact output (if assigned) and the front panel TRIP indicator.

The low-set element can be selectively blocked by the digital input if the appropriate switch settings in Soft Switch 9A and Soft Switch 9B are set accordingly.

#### 2.3.1 Inverse time delay characteristic

The inverse characteristic for negative sequence overvoltage  $U_2$ , is defined by the following equation:

$$t = \left[ \frac{\text{TMS}}{\left| \frac{V}{V_s} - 1 \right|} \right]$$

where:

- t = operating time in seconds
- TMS = time multiplier setting
- V = calculated negative sequence voltage
- V<sub>s</sub> = relay setting voltage

NOTE: this equation is valid for  $V > V_s$

*Negative sequence overvoltage characteristic*

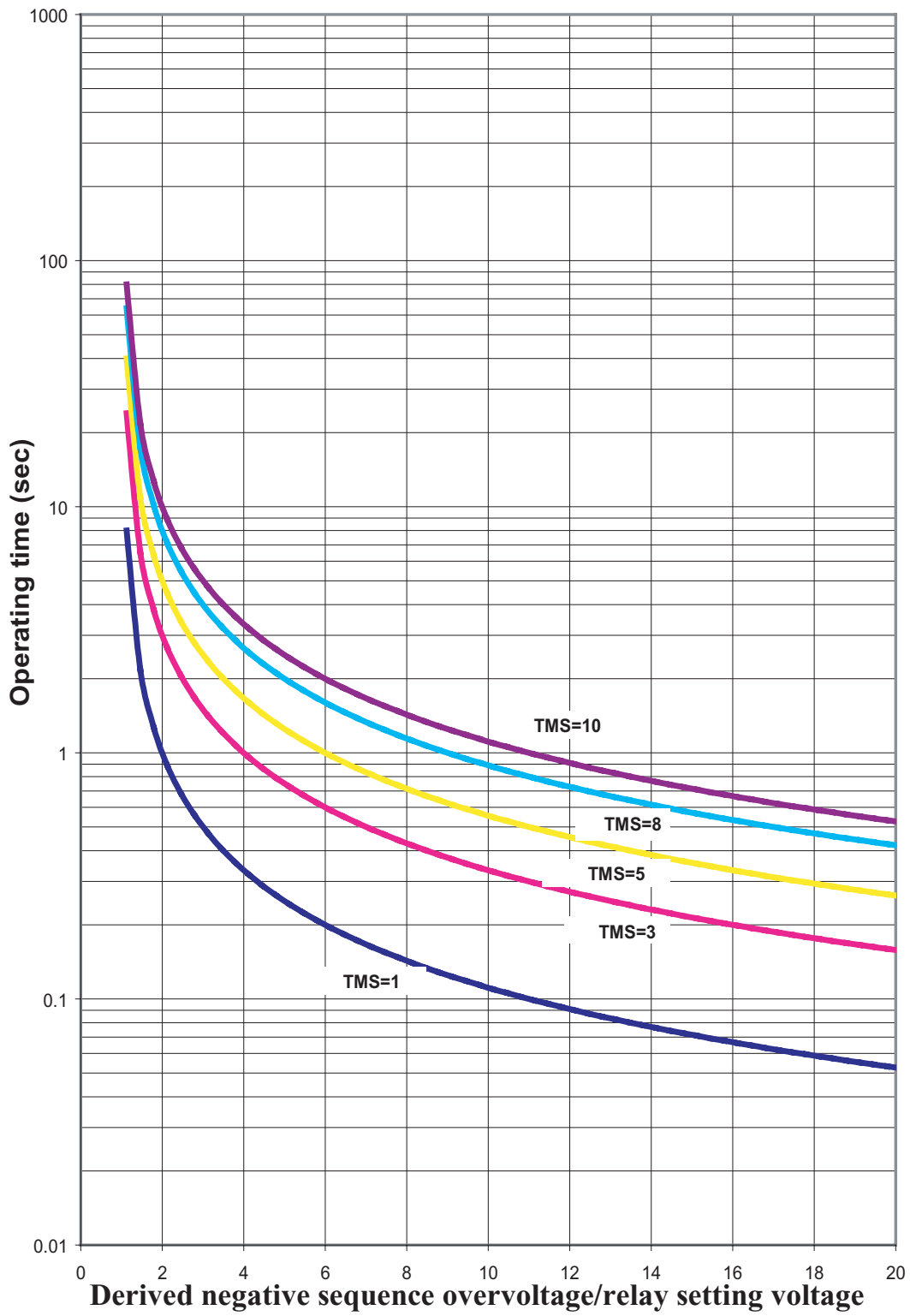

Figure 3: Inverse time curves for the overvoltage element “U<sub>2</sub>>”

## 2.4 Neutral displacement /Residual Overvoltage (59N)

For residual overvoltage on MU2300, there is only low-set element. The residual voltage is either derived from the three phase-to-neutral voltage measurements of the voltage inputs or is measured directly from the residual voltage transformer depending on the setting of Soft Switch A. If the relay is configured in Soft Switch A to measure the phase-to-phase voltages, the residual voltage must be measured by the residual voltage transformer.

When the residual overvoltage value rises above the set low-set residual overvoltage value, the low-set residual overvoltage element will start and deliver a start signal to the contact output (if assigned) and the front panel START indicator. After a pre-set delay time, determined by the user's selection between definite-time and inverse time characteristic, the residual overvoltage element delivers a trip signal to the contact output (if assigned) and the front panel TRIP indicator.

The low-set element can be selectively blocked by the digital input if the appropriate switch settings in Soft Switch 9A and Soft Switch 9B are set accordingly.

### 2.4.1 Inverse time delay characteristic

The inverse characteristic for residual overvoltage  $U_{0>}$ , is defined by the following equation:

$$t = \left[ \frac{\text{TMS}}{\left| \frac{V}{V_s} - 1 \right|} \right]$$

where:

- t = operating time in seconds
- TMS = time multiplier setting
- V = applied or derived residual input voltage
- V<sub>s</sub> = relay setting voltage

NOTE: this equation is valid for  $V > V_s$

*Residual overvoltage characteristic*

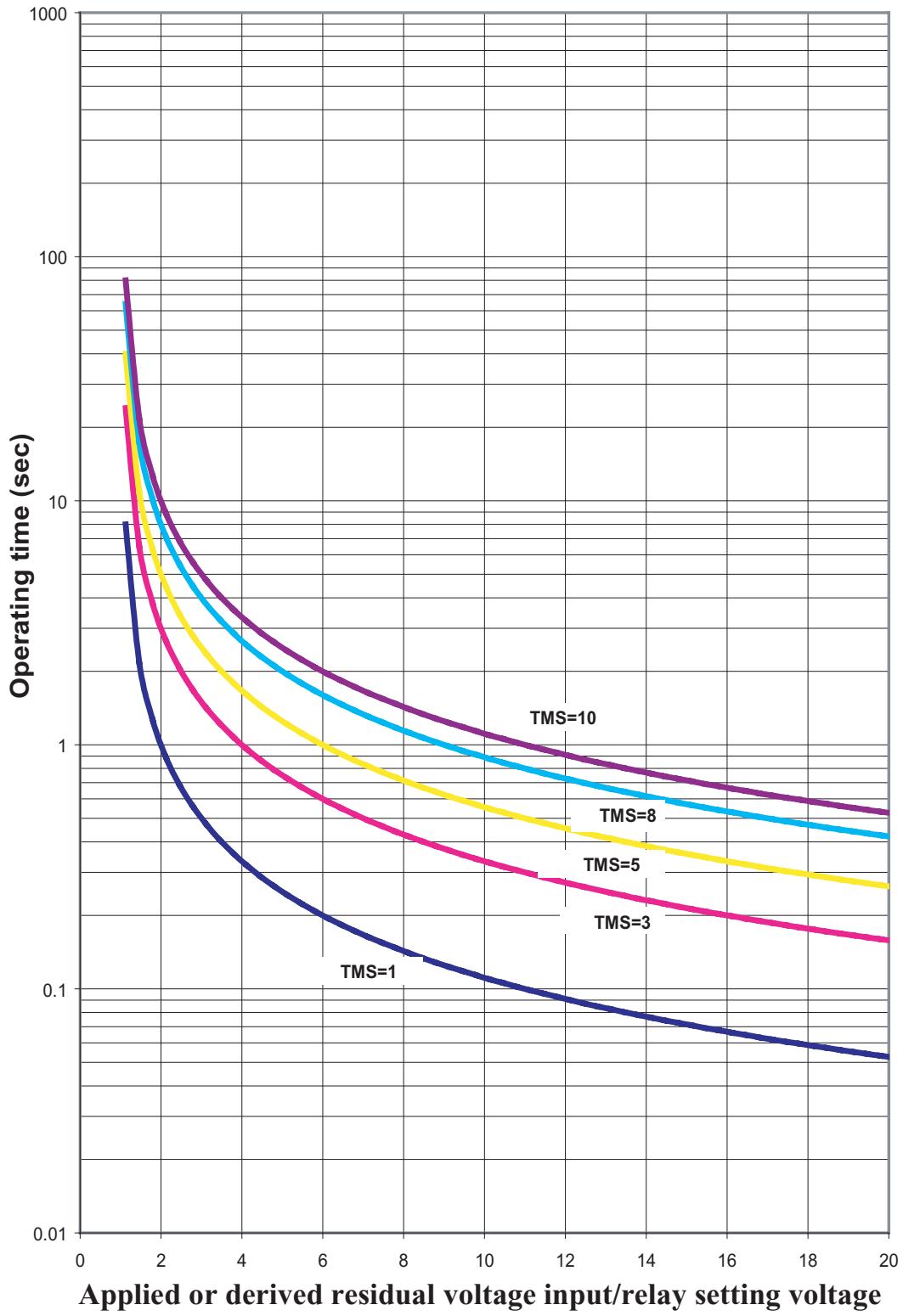
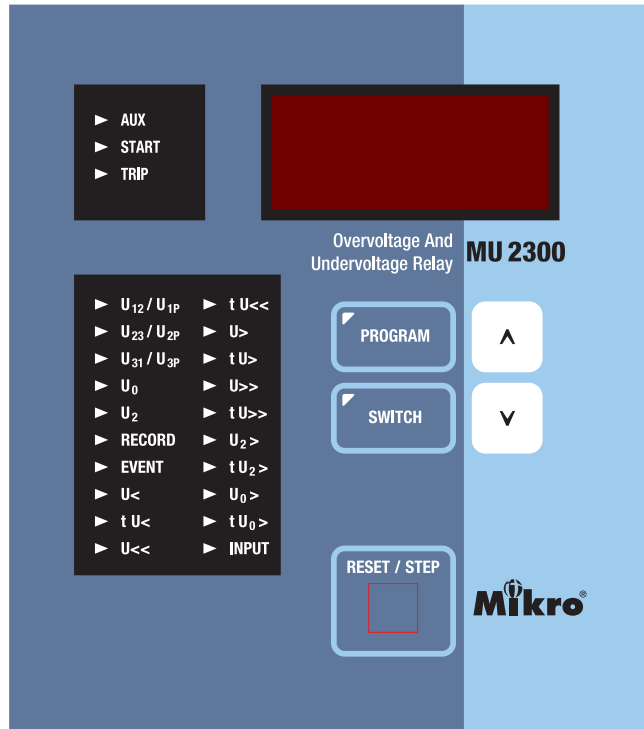

Figure 4: Inverse time curves for the overvoltage element “U<sub>0</sub>>”

### 3. Display



#### 3.1 Indicators

a) ▶ **AUX**

This is the power indicator. It shows the presence of auxiliary power supply to the MU2300 relay.

b) ▶ **START**

This indicator lights up when any or all of the protection elements, namely, undervoltage protection, overvoltage protection, negative sequence overvoltage and residual overvoltage elements are started (pick-up).

c) ▶ **TRIP**

This indicator lights up when any or all of the protection elements, namely, undervoltage protection, overvoltage protection, negative sequence overvoltage and residual overvoltage elements are started (pick-up) due to fault conditions and subsequently tripped due to the sustained fault condition.

d) Digit display

The two formats of the display are as shown below:

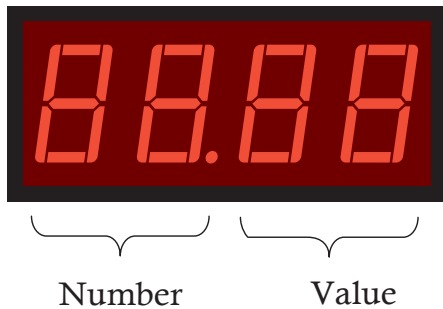
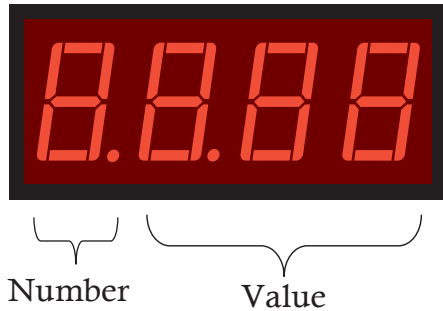

The “Number” is for displaying the item selected and the “Value” is to show the corresponding parameter associated with the item “Number” selected.

e) ► **U<sub>12</sub>/ U<sub>1P</sub>**

When this indicator is lighted, the digit display is showing the value of either U1 phase-to-neutral voltage or U12 phase-to-phase voltage. When the phase-to-neutral voltage is shown, the “Number” field of the digit display shows an alphabet “P” whereas when phase-to-phase voltage is shown, the “Number” field displays an alphabet “L”.

This indicator blinks when the undervoltage or overvoltage protection element corresponding to U1 or U12 pick-up or tripped.

f) ► **U<sub>23</sub>/U<sub>2P</sub>**

Similar to item e) above, this indicator shows the U2 phase-to-neutral voltage or U23 phase-to-phase voltage.

g) ► **U<sub>31</sub>/U<sub>3P</sub>**

Similar to item e) above, this indicator shows the U3 phase-to-neutral voltage or U31 phase-to-phase voltage.

h) ► **U<sub>0</sub>**

When this indicator is lighted, the digit display shows the residual voltage. It blinks when the corresponding protection element pick-up or trip.

i) ► **U<sub>2</sub>**

When this indicator is lighted, the digit display shows the negative sequence voltage. It blinks when the corresponding protection element pick-up or trip.

j) ► **Record**

This indicator will light up simultaneously with either U12/U1P, U23/U2P, U31/U3P, U0, or U2. When lighted, the digit display is showing the previously recorded voltages at then moment when MU2300 trips. There are nine records available and each can be viewed at by pressing the DOWN key. Record number 1 is the latest record.

k) ► **Event**

When this indicator is lighted, the digit display is showing the recorded event code. There are 60 numbers of events available and

all the recorded events will be cleared when the auxiliary power supply to MU2300 is disconnected. The event code is in Appendix C.

All event registered will be displayed one-by-one automatically if the relay is left untouched in this mode of for about 20 seconds.

l)  **U<**

When this indicator is lighted, the digit display shows the low-set undervoltage setting. The “Number” field of the digit display indicates whether it is a Group A or Group B setting. The “Value” field shows the setting voltage.

m)  **tU<**

When this indicator is lighted, depending on the user setting on Soft Switch 7, the digit display will either show the TMS or the definite time delay for low-set undervoltage. The “Number” field of the digit display shows whether it is a Group A or Group B setting.

n)  **U<<**

When this indicator is lighted, the digit display shows the high-set undervoltage setting. The “Number” field of the digit display indicates whether it is a Group A or Group B setting. The “Value” field shows the setting voltage.

o)  **tU<<**

When this indicator is lighted, the digit display shows the high-set definite time delay for undervoltage. The “Number” field of the digit display shows whether it is a Group A or Group B setting.



p) ► **U>**

When this indicator is lighted, the digit display shows the low-set overvoltage setting. The “Number” field of the digit display indicates whether it is a Group A or Group B setting. The “Value” field shows the setting voltage.

q) ► **tU>**

When this indicator is lighted, depending on the user setting on Soft Switch 7, the digit display will either show the TMS or the definite time delay for low-set overvoltage. The “Number” field of the digit display shows whether it is a Group A or Group B setting.

r) ► **U>>**

When this indicator is lighted, the digit display shows the high-set overvoltage setting. The “Number” field of the digit display indicates whether it is a Group A or Group B setting. The “Value” field shows the setting voltage.

s) ► **tU>>**

When this indicator is lighted, the digit display shows the high-set definite time delay for overvoltage. The “Number” field of the digit display shows whether it is a Group A or Group B setting.

t) ► **U<sub>2</sub>>**

When this indicator is lighted, the digit display shows the low-set negative sequence overvoltage setting. The “Number” field of the digit display indicates whether it is a Group A or Group B setting. The “Value” field shows the setting for the negative sequence overvoltage.

u) **▶ tU<sub>2</sub>>**

When this indicator is lighted, depending on the user setting on Soft Switch 7, the digit display will either show the TMS multiplier or the definite time delay for low-set negative sequence overvoltage. The “Number” field of the digit display shows whether it is a Group A or Group B setting.

v) **▶ U<sub>0</sub>>**

When this indicator is lighted, the digit display shows the low-set residual overvoltage setting. The “Number” field of the digit display indicates whether it is a Group A or Group B setting. The “Value” field shows the setting for the residual overvoltage.

w) **▶ tU<sub>0</sub>>**

When this indicator is lighted, depending on the user setting on Soft Switch 7, the digit display will either show the TMS or the definite time delay for low-set residual overvoltage. The “Number” field of the digit display shows whether it is a Group A or Group B setting.

x) **▶ INPUT**

This indicator reflects the status of the external digital input regardless of the soft switches setting. It is a direct mimic of the status of the input. When voltage is applied to the digital input, the indicator will turn on.

### 3.2 Normal Status Display

Under normal operating condition where non of the protection elements have operated and the key are not pressed, all the indicators will be switched off except the following:

a) **▶ AUX**

The AUX indicator shows that there is power supply to the relay.

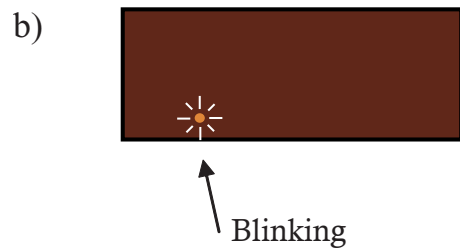

The decimal point on the left-most digit blinks to indicate that the relay is functioning normally.

### 3.3 Start Status Display

The Start indicator lights up when any of the protection elements pick-up (started). Other indicators also lighted simultaneously to show which protection elements have started.

- a) The Start indicator light up to indicate that the relay pick up.

▶ **START**

- b) One or more of the following indicators blink to indicate the sources of the pick-up.

▶ **U<sub>12</sub>/U<sub>1P</sub>**

▶ **U<sub>23</sub>/U<sub>2P</sub>**

▶ **U<sub>31</sub>/U<sub>3P</sub>**

▶ **U<sub>0</sub>**

▶ **U<sub>2</sub>**

- c) One or more of the following indicators blink to indicate that the protection elements that have pick-up.

▶ **U<**

▶ **U<<**

▶ **U>**

▶ **U>>**

▶ **U<sub>2</sub>>**

▶ **U<sub>0</sub>>**

### 3.4 Trip Status Display

The Trip indicator lights up when any of the protection elements trip. Other indicators also lighted simultaneously to show which protection elements have tripped.

- a) The Trip indicator light up to indicates that the relay has tripped. It stays steady when the condition for tripping has not been removed. Otherwise, the indicator blinks.

▶ **TRIP**

- b) One of the following indicators blink to indicate the sources of the pick-up.

▶  **$U_{12}/U_{1P}$**

▶  **$U_{23}/U_{2P}$**

▶  **$U_{31}/U_{3P}$**

▶  **$U_0$**

▶  **$U_2$**

- c) One of the following indicators blink to indicate that the protection elements that have pick-up.

▶  **$U<$**

▶  **$U<<$**

▶  **$U>$**

▶  **$U>>$**

▶  **$U_2>$**

▶  **$U_0>$**

- d) The digit display shows the value of the trip voltage at the moment of tripping. The “Number” field of the digit display may indicate an alphabet “L” or “P” which denote phase-to-phase voltage or phase-to-neutral voltage respectively.



Number                  Value

When the voltage value is not available, the display will show “-E-“ sign on the “Value” field.

## 4. Key Button Input

a) RESET/STEP key

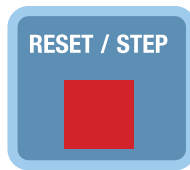

This key has two functions:

- I. To reset the relay when the relay is tripped.
- II. To select the items to be view at such as all the input voltages and setting parameters.

The sequence of selection when the RESET/STEP key is pressed is as shown below. Pressing the UP key will reverse the sequence.

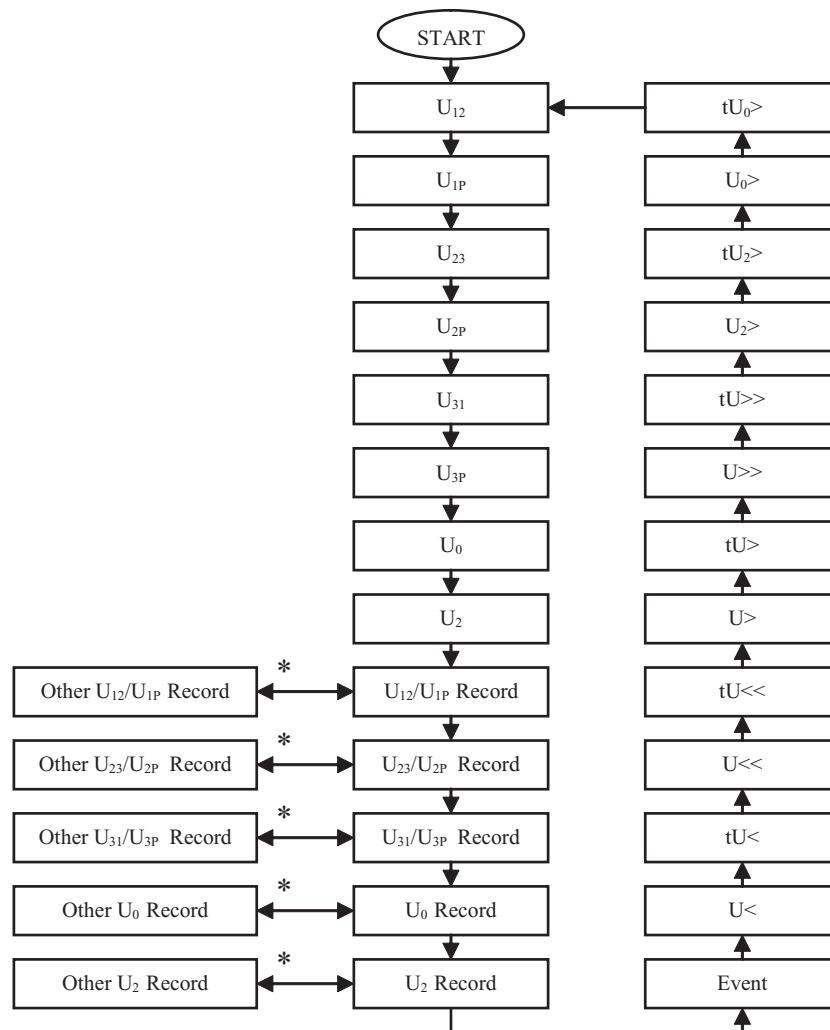

\* Use DOWN key

b) The PROGRAM key



Item to be programmed is first selected by the RESET/STEP key. Then pressing the PROGRAM key set the relay into programming mode for the selected item. Value of the selected item can then be changed by the UP or DOWN key. Pressing the PROGRAM key again while in the programming mode will cause the relay to exit from the programming mode with the new value saved into the non-volatile memory.

The indicator adjacent to the PROGRAM key will light up when in programming mode.

c) The UP and DOWN keys



These keys are for changing the value of the selected item while in programming mode. Under non-programming mode, the UP key is used as the reverse STEP key and the DOWN key is used for changing the record number while in the recorded data retrieval mode.

d) The SWITCH key



Press this key to step through all the soft switches.



## 5. Programming

### 5.1 To program the setting for $U <$ , $U <<$ , $U >$ , $U >>$ , $U_0 >$ , and $U_2 >$

#### Step 1

Select the required item by stepping through all the items using the RESET/STEP key or the UP key. The corresponding light for the selected item will be lighted.

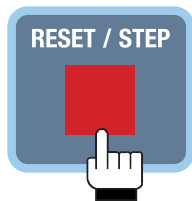

#### Step 2

Press the PROGRAM key once. The indicator for the selected item will blink and the indicator for PROGRAM key lights up to indicate that the system is now in programming mode.



#### Step 3

Use the UP or DOWN key to select the desired value. Hold down the key until the desired value appears.

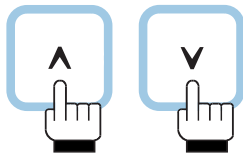

#### Step 4

To save the changed value, press the PROGRAM key again. The indicator for the PROGRAM key will turn off and the blinking indicator for the selected item stop blinking.

To abort without saving the selected setting, press the RESET/STEP key. Programming is prohibited when the relay is started or tripped.



## 5.2 To program the soft switches

### Step 1

Press the SWITCH key until the desired switch number appears on the display.

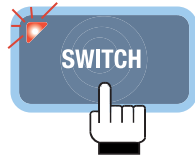

### Step 2

Press the PROGRAM key to enter into programming mode. The switch number on the “Number” field of the digit display blinks to indicate that the system is now in soft switch programming mode. The indicators for the PROGRAM and the SWITCH keys also light up.



### Step 3

Use the UP or DOWN key for changing the soft switch setting. Hold down the key until the desired value appears.

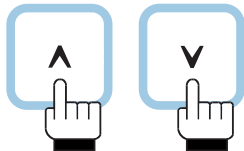

### Step 4

Press the PROGRAM key again to save the changed setting. The switch number will stop blinking and the indicator for the PROGRAM key will be switched off.

To abort without saving the change, press the SWITCH key or RESET/STEP key. Programming is prohibited when the relay is started or tripped.

## 6 Soft Switches

Soft switches are used to configure the features of the relay and the functional characteristic of the relays outputs.

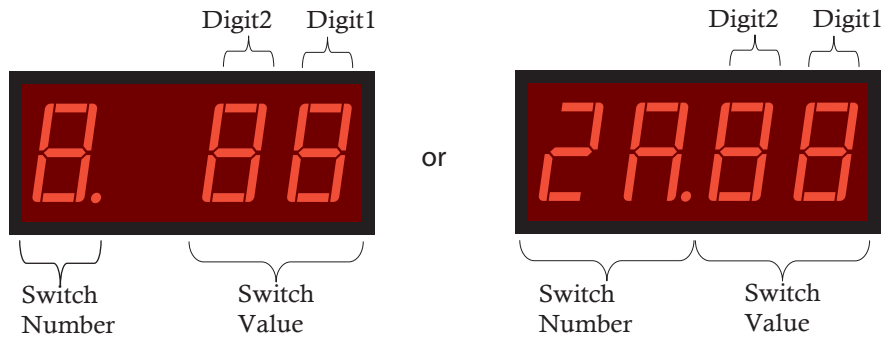

### Soft Switch 1A to Soft Switch 5A

These switches are for configuring the output contacts R1 to R5 in relation to low-set undervoltage  $U<$ , high-set undervoltage  $U<<$ , low-set overvoltage  $U>$  and high-set overvoltage  $U>>$ .

For contact output R1

	S1A.7	S1A.6	S1A.5	S1A.4	S1A.3	S1A.2	S1A.1	S1A.0
Default setting	1	0	1	0	1	0	1	0
Default setting – hexadecimal value	A				A			
User's setting								
User's setting – hexadecimal value								

For contact output R2

	S2A.7	S2A.6	S2A.5	S1A.4	S2A.3	S1A.2	S2A.1	S2A.0
Default setting	0	1	0	1	0	1	0	1
Default setting – hexadecimal value	5				5			
User's setting								
User's setting – hexadecimal value								

### For contact output R3

	S3A.7	S3A.6	S3A.5	S3A.4	S3A.3	S3A.2	S3A.1	S3A.0
Default setting	0	0	0	0	0	0	0	0
Default setting – hexadecimal value	0				0			
User's setting								
User's setting – hexadecimal value								

### For contact output R4

	S4A.7	S4A.6	S4A.5	S4A.4	S4A.3	S4A.2	S4A.1	S4A.0
Default setting	0	0	0	0	0	0	0	0
Default setting – hexadecimal value	0				0			
User's setting								
User's setting – hexadecimal value								

### For contact output R5

	S5A.7	S5A.6	S5A.5	S5A.4	S5A.3	S5A.2	S5A.1	S5A.0
Default setting	0	0	0	0	0	0	0	0
Default setting – hexadecimal value	0				0			
User's setting								
User's setting – hexadecimal value								

### SxA.0

This switch element is to connect/disconnect the corresponding contact output Rx to low-set undervoltage (U <) START signal.

- 1 = Rx is connected to low-set undervoltage START signal.
- 0 = Rx is disconnected to low-set undervoltage START signal

### SxA.1

This switch element is to connect/disconnect the corresponding contact output Rx to low-set undervoltage (U <) TRIP signal.

- 1 = Rx is connected to low-set undervoltage TRIP signal.
- 0 = Rx is disconnected to low-set undervoltage TRIP signal.

**SxA.2**

This switch element is to connect/disconnect the corresponding contact output Rx to high-set undervoltage ( $U \ll$ ) START signal.

- 1 = Rx is connected to high-set undervoltage START signal.
- 0 = Rx is disconnected to high-set undervoltage START signal.

**SxA.3**

This switch element is to connect/disconnect the corresponding contact output Rx to high-set undervoltage ( $U \ll$ ) TRIP signal.

- 1 = Rx is connected to high-set undervoltage TRIP signal.
- 0 = Rx is disconnected to high-set undervoltage sTRIP signal.

**SxA.4**

This switch element is to connect/disconnect the corresponding contact output Rx to low-set overvoltage ( $U >$ ) START signal.

- 1 = Rx is connected to low-set overvoltage START signal.
- 0 = Rx is disconnected to low-set overvoltage START signal.

**SxA.5**

This switch element is to connect/disconnect the corresponding contact output Rx to low-set overvoltage ( $U >$ ) TRIP signal.

- 1 = Rx is connected to low-set overvoltage TRIP signal.
- 0 = Rx is disconnected to low-set overvoltage TRIP signal.

**SxA.6**

This switch element is to connect/disconnect the corresponding contact output Rx to high-set overvoltage ( $U \gg$ ) START signal.

- 1 = Rx is connected to high-set overvoltage start signal.
- 0 = Rx is disconnected to high-set overvoltage start signal.

**SxA.7**

This switch element is to connect/disconnect the corresponding contact output Rx to high-set overvoltage ( $U \gg$ ) TRIP signal.

- 1 = Rx is connected to high-set overvoltage trip signal.
- 0 = Rx is disconnected to low-set overvoltage trip signal.

### ***Soft Switch 1B to Soft Switch 5B***

These switches are for configuring the output contacts R1 to R5 in relation to low-set negative sequence overvoltage  $U_{2>}$  and low-set residual overvoltage  $U_0$ .

#### For contact output R1

	S1B.7	S1B.6	S1B.5	S1B.4	S1B.3	S1B.2	S1B.1	S1B.0
Default setting	0	0	1	0	0	0	1	0
Default setting – hexadecimal value	2				2			
User's setting								
User's setting – hexadecimal value								

#### For contact output R2

	S2B.7	S2B.6	S2B.5	S2B.4	S2B.3	S2B.2	S2B.1	S2B.0
Default setting	0	0	0	1	0	0	0	1
Default setting – hexadecimal value	1				1			
User's setting								
User's setting – hexadecimal value								

#### For contact output R3

	S3B.7	S3B.6	S3B.5	S3B.4	S3B.3	S3B.2	S3B.1	S3B.0
Default setting	0	0	0	0	0	0	0	0
Default setting – hexadecimal value	0				0			
User's setting								
User's setting – hexadecimal value								

#### For contact output R4

	S4B.7	S4B.6	S4B.5	S4B.4	S4B.3	S4B.2	S4B.1	S4B.0
Default setting	0	0	0	0	0	0	0	0
Default setting – hexadecimal value	0				0			
User's setting								
User's setting – hexadecimal value								

#### For contact output R5

	S5B.7	S5B.6	S5B.5	S5B.4	S5B.3	S5B.2	S5B.1	S5B.0
Default setting	0	0	0	0	0	0	0	0
Default setting – hexadecimal value	0				0			
User's setting								
User's setting – hexadecimal value								

#### **SxB.0**

This switch element is to connect/disconnect the corresponding contact output Rx to low-set residual overvoltage ( $U_0 >$ ) START signal.

- 1 = Rx is connected to low-set residual overvoltage start signal
- 0 = Rx is disconnected to low-set residual overvoltage start signal.

#### **SxB.1**

This switch element is to connect/disconnect the corresponding contact output Rx to low-set residual overvoltage ( $U_0 >$ ) TRIP signal.

- 1 = Rx is connected to low-set residual overvoltage
- 0 = Rx is disconnected to low-set residual overvoltage signal.

#### **SxB.2**

Not used.

#### **SxB.3**

Not used.



**SxB.4**

This switch element is to connect/disconnect the corresponding contact output Rx to low-set negative sequence overvoltage ( $U_2 >$ ) START signal.

- 1 = Rx is connected to low-set negative sequence overvoltage start signal.
- 0 = Rx is disconnected to low-set negative sequence overvoltage start signal

**SxB.5**

This switch element is to connect/disconnect the corresponding contact output Rx to low-set negative sequence overvoltage ( $U_2 >$ ) TRIP signal.

- 1 = Rx is connected to low-set negative sequence overvoltage trip signal.
- 0 = Rx is disconnected to low-set negative sequence overvoltage trip signal.

**SxB.6**

Not used.

**SxB.7**

Not used.

## **Soft Switch 6A**

This switch is for setting the characteristic of output contacts R1 to R5 in relation to the START signal issued by the protection elements assigned to them by Switch1A to Switch5A or Switch1B to Switch5B above. These output contacts can be configured to be auto-reset type or manual-reset type. For auto-reset type, the output contacts will automatically return to the normal state upon removal of the condition which triggers the START signal. In the case of manual-reset type, the output contacts will latch on regardless of the condition which triggers the START signal until the relay is manually reset by the user by pressing the RESET/STEP key.

Switch elements S6A.5 and S6A.6 are for configuring the START signals due to low-set/high-set undervoltage elements and low-set/high-set overvoltage elements respectively such that condition for a valid START signal to be effected on the output contacts R1 to R5 (if configured) can either be from any one phase or from the three phases which occur concurrently.

	S6A.7	S6A.6	S6A.5	S6A.4	S6A.3	S6A.2	S6A.1	S6A.0
Default setting	0	0	0	0	0	0	0	0
Default setting – hexadecimal value	0				0			
User's setting								
User's setting – hexadecimal value								

### **S6A.0**

This switch element configures the characteristic of output contact R1 in relation to START signal.

- 1 = Manual reset for R1.
- 0 = Auto reset for R1.

### **S6A.1**

This switch element configures the characteristic of output contact R2 in relation to START signal.

- 1 = Manual reset for R2.
- 0 = Auto reset for R2.

### **S6A.2**

This switch element configures the characteristic of output contact R3 in relation to START signal.

- 1 = Manual reset for R3.
- 0 = Auto reset for R3.

### **S6A.3**

This switch element configures the characteristic of output contact R4 in relation to START signal.

- 1 = Manual reset for R4.
- 0 = Auto reset for R4.

### **S6A.4**

This switch element configures the characteristic of output contact R5 in relation to START signal.

- 1 = Manual reset for R5.
- 0 = Auto reset for R5.

### **S6A.5**

This switch element configures the START signal from low-set or high-set undervoltage elements for R1 to R5 above.

- 1 = All three phases of the low-set or high-set undervoltage elements must start concurrently for a valid START signal to be delivered to R1 to R5.
- 0 = Any single or more phases low-set or high-set undervoltage elements can trigger a valid START signal to R1 to R5.

### **S6A.6**

This switch element configures the START signal from low-set or high-set overvoltage elements for R1 to R5 above.

- 1 = All three phases of the low-set or high-set overvoltage elements must start concurrently for a valid START signal to be delivered to R1 to R5.
- 0 = Any single or more phases low-set or high-set overvoltage elements can trigger a valid START signal to R1 to R5.

### **S6A.7**

Not used.

## ***Soft Switch 6B***

This switch is for setting the characteristic of output contacts R1 to R5 in relation to the TRIP signal issued by the protection elements assigned to them by Switch1A to Switch5A or Switch1B to Switch5B above. These output contacts can be configured to be auto-reset type or manual-reset type. For auto-reset type, the output contacts will automatically return to the normal state upon removal of the condition which triggers the TRIP signal. In the case of manual-reset type, the output contacts will latch on regardless of the condition which triggers the TRIP signal until the relay is manually reset by the user by pressing the RESET/STEP key.

Switch elements S6B.5 and S6B.6 are for configuring the TRIP signals due to low-set/high-set undervoltage elements and low-set/high-set overvoltage elements respectively such that condition for a valid TRIP signal to be effected on the output contacts R1 to R5 (if configured) can either be from any one phase or from the three phases which occur concurrently.

	S6B.7	S6B.6	S6B.5	S6B.4	S6B.3	S6B.2	S6B.1	S6B.0
Default setting	0	0	0	0	0	0	0	0
Default setting – hexadecimal value	0				0			
User's setting								
User's setting – hexadecimal value								

### **S6B.0**

This switch element configures the characteristic of output contact R1 in relation to TRIP signal.

- 1 = Manual reset for R1.
- 0 = Auto reset for R1.

### **S6B.1**

This switch element configures the characteristic of output contact R2 in relation to TRIP signal.

- 1 = Manual reset for R2.
- 0 = Auto reset for R2.

### **S6B.2**

This switch element configures the characteristic of output contact R3 in relation to TRIP signal.

- 1 = Manual reset for R3.
- 0 = Auto reset for R3.

### **S6B.3**

This switch element configures the characteristic of output contact R4 in relation to TRIP signal.

- 1 = Manual reset for R4.
- 0 = Auto reset for R4.

### **S6B.4**

This switch element configures the characteristic of output contact R5 in relation to TRIP signal.

- 1 = Manual reset for R5.
- 0 = Auto reset for R5.

### **S6B.5**

This switch element configures the TRIP signal from low-set or high-set undervoltage elements for R1 to R5 above.

- 1 =All three phases of the low-set or high-set undervoltage elements must TRIP concurrently for a valid TRIP signal to be delivered to R1 to R5.
- 0 =Any single or more phases low-set or high-set undervoltage elements can trigger a valid TRIP signal to R1 to R5.

### **S6B.6**

This switch element configures the TRIP signal from low-set or high-set overvoltage elements for R1 to R5 above.

- 1 =All three phases of the low-set or high-set overvoltage elements must TRIP concurrently for a valid TRIP signal to be delivered to R1 to R5.
- 0 =Any single or more phases low-set or high-set overvoltage elements can trigger a valid TRIP signal to R1 to R5.

### **S6B.7**

Not used.

## **Soft Switch 7**

This soft switch allows the user to choose between definite time setting and inverse time setting for the low-set undervoltage, low-set overvoltage, low-set negative sequence overvoltage and low-set residual overvoltage.

There are two groups of settings available for the above protection elements namely, Group A and Group B. All of the settings can be individually set for either definite time or inverse time. Switch elements S7.0 to S7.3 are for Group A settings and S7.4 to S7.7 are for Group B settings.

	S7.7	S7.6	S7.5	S7.4	S7.3	S7.2	S7.1	S7.0
Default setting	1	1	1	1	1	1	1	1
Default setting – hexadecimal value	F (Group B)				F (Group A)			
User's setting								
User's setting – hexadecimal value								

### **S7.0**

Group A low-set undervoltage time delay setting.

- 1 = Inverse time
- 0 = Definite time

### **S7.1**

Group A low-set overvoltage time delay setting.

- 1 = Inverse time
- 0 = Definite time

### **S7.2**

Group A low-set negative sequence overvoltage time delay setting.

- 1 = Inverse time
- 0 = Definite time

**S7.3**

Group A low-set residual overvoltage time delay setting.

- 1 = Inverse time
- 0 = Definite time

**S7.4**

Group B low-set undervoltage time delay setting.

- 1 = Inverse time
- 0 = Definite time

**S7.5**

Group B low-set overvoltage time delay setting.

- 1 = Inverse time
- 0 = Definite time

**S7.6**

Group B low-set negative sequence overvoltage time delay setting.

- 1 = Inverse time
- 0 = Definite time

**S7.7**

Group B low-set residual overvoltage time delay setting.

- 1 = Inverse time
- 0 = Definite time

## ***Soft Switch 8***

This soft switch allows the user to enable or disable the high-set undervoltage, high-set overvoltage, low-set residual overvoltage and low-set negative sequence overvoltage for both Group A and Group B

	S8.7	S8.6	S8.5	S8.4	S8.3	S8.2	S8.1	S8.0
Default setting	1	1	1	1	1	1	1	1
Default setting – hexadecimal value	F (Group B)				F (Group A)			
User's setting								
User's setting – hexadecimal value								

### **S8.0**

For enabling Group A high-set undervoltage element.

- 1 = Enabled
- 0 = Disabled

### **S8.1**

For enabling Group A high-set overvoltage element.

- 1 = Enabled
- 0 = Disabled

### **S8.2**

For enabling Group A low-set residual overvoltage

- 1 = Enabled
- 0 = Disabled

### **S8.3**

For enabling Group A low-set negative sequence overvoltage

- 1 = Enabled
- 0 = Disabled



**S8.4**

For enabling Group B high-set undervoltage element.

1 = Enabled  
0 = Disabled

**S8.5**

For enabling Group B high-set overvoltage element.

1 = Enabled  
0 = Disabled

**S8.6**

For enabling Group B low-set residual overvoltage

1 = Enabled  
0 = Disabled

**S8.7**

For enabling Group A low-set negative sequence overvoltage

1 = Enabled  
0 = Disabled

## ***Soft Switch 9A***

This switch is for configuring the function of the digital input. Only one selection is possible.

	S9A.7	S9A.6	S9A.5	S9A.4	S9A.3	S9A.2	S9A.1	S9A.0
Default setting	0	0	0	0	1	0	0	0
Default setting – hexadecimal value	0				8			
User's setting								
User's setting – hexadecimal value								

### **S9A.0**

The input is configured for switching between Group A setting and Group B setting.

- 1 = Selected.
- 0 = Not selected.

### **S9A.1**

The input is configured as remote trip reset input.

- 1 = Selected.
- 0 = Not selected.

### **S9A.2**

The input is configured as external tripping input source.

- 1 = Selected.
- 0 = Not selected.

### **S9A.3**

The input is configured as blocking input.

- 1 = Selected.
- 0 = Not selected.

**S9A.4**

Not used.

**S9A.5**

Not used.

**S9A.6**

Not used.

**S9A.7**

Not used.

## ***Soft Switch 9B***

This switch will only function if switch element S9A.3 is set to 1 making the digital input as a blocking input. The switch elements of Switch 9B allow the user to individually select the blocking of low-set undervoltage, low-set overvoltage, low-set negative sequence overvoltage, low-set residual overvoltage, high-set undervoltage, and high-set overvoltage.

	S9B.7	S9B.6	S9B.5	S9B.4	S9B.3	S9B.2	S9B.1	S9B.0
Default setting	0	0	0	0	0	0	0	0
Default setting – hexadecimal value	0				0			
User's setting								
User's setting – hexadecimal value								

### **S9B.0**

Low-set undervoltage blocked.

- 1 = Block
- 0 = Unblock

### **S9B.1**

High-set undervoltage blocked.

- 1 = Block
- 0 = Unblock

### **S9B.2**

Low-set overvoltage blocked.

- 1 = Block
- 0 = Unblock

### **S9B.3**

High-set overvoltage blocked.

- 1 = Block
- 0 = Unblock

**S9B.4**

Low-set negative sequence overvoltage blocked.

1 = Block

0 = Unblock

**S9B.5**

Low-set residual overvoltage blocked.

1 = Block

0 = Unblock

**S9B.6**

Not used.

**S9B.7**

Not used.

### ***Soft Switch A***

This switch sets the voltage transformer (VT) configuration for MU2300. There are 4 possible VT configurations as shown in Examples 1 to 4 under the “Connection Diagram & Terminal Connection” section. It is important to choose the correct connection type failing which the wrong voltages will be measured or derived by MU2300.

	SA.7	SA.6	SA.5	SA.4	SA.3	SA.2	SA.1	SA.0
Default setting	0	0	0	0	0	0	0	1
Default setting – hexadecimal value	0				1			
User’s setting								
User’s setting – hexadecimal value								

#### **SA.0**

This switch element is for selection of “3Vpn” configuration as shown in Example 1. In this configuration, the measured voltages are the phase-to-neutral voltage for the three phases. The phase-to-phase voltages and the residual voltage are derived internally.

- 1 = selected
- 0 = Not selected

#### **SA.1**

This switch element is for selection of “3Vpn + Vo” configuration as shown in Example 2. In this configuration, the measured voltages are the phase-to-neutral voltage for the three phases and the residual overvoltage. The phase-to-phase voltages are derived internally.

- 1 = selected
- 0 = Not selected

**SA.2**

This switch element is for selection of “3Vpp + Vo” configuration as shown in Example 3. In this configuration, the measured voltages are the phase-to-phase voltage for the three phases and the residual overvoltage. The phase-to-neutral voltages are not available.

- 1 = selected
- 0 = Not selected

**SA.3**

This switch element is for selection of “2Vpp + Vo” configuration as shown in Example 4. In this configuration, the measured voltages are the 2 phase-to-phase voltages and the residual overvoltage. The third phase-to-phase voltage is derived internally and phase-to-neutral voltages are not available.

- 1 = selected
- 0 = Not selected

**SA.4**

Not used.

**SA.5**

Not used.

**SA.6**

Not used.

**SA.7**

Not used.

### ***Soft Switch B***

This soft switch selects the baud rate and data format of the serial Modbus communication between the host computer (client) and the relay MU2300 (server).

	Digit 2	Digit 1
Default setting	4	7
User's setting		

Digit 1 is for selecting the communication baud rate.

Baud rate	Value of Digit 1
300	1
600	2
1200	3
2400	4
4800	5
9600	6
19200	7

Digit 2 is for selecting the data format.

Data format	Value of Digit 2
1 start bit, 8 data bits, no parity bit, 1 stop bit	1
1 start bit, 8 data bits, no parity bit, 2 stop bits	2
1 start bit, 8 data bits, odd parity bit, 1 stop bit	3
1 start bit, 8 data bits, even parity bit, 1 stop bit	4



### *Soft Switch C*

This soft switch is for setting the device unit number of MU2300 in a Modbus communication network. The setting range for the device unit is from 1 to 127 and it is displayed and set in hexadecimal format.

Example:

If the selected unit number is 42, then the equivalent hexadecimal number is 2A. For conversation between hexadecimal number and decimal number, please refer to Appendix B.

The default unit number is 1.

### ***Soft Switch D***

This soft switch allows the user to either allow or disallow remote programming or changing of the setting values of the MU2300 relay. Once enabled, the remote host computer (client) is able to read and modify all the settings and parameters of the relay through the serial communication channel using Modbus protocol. Otherwise, only reading of the setting values and relay parameters is possible.

- 1 – Remote programming is enabled.
- 0 – Remote programming is disabled.

The default setting for MU2300 is remote programming disabled (0).

### ***Soft Switch E***

This switch allows the contacts output of MU2300 to be manually and individually switched on. This is very useful during testing and commissioning of the relay.

Description	Display Value
Off all contact outputs	00
On contact output R1 only	01
On contact output R2 only	02
On contact output R3 only	03
On contact output R4 only	04
On contact output R5 only	05

Steps to turn on a contact:

1. Select soft switch E by pressing the SWITCH key.
2. Press PROGRAM key.
3. Press UP or DOWN key to select the desired contact.
4. Press SWITCH or PROGRAM key to exit.

Note that all contacts will be switched OFF after the above test regardless of the previous status of the contact outputs prior to the test.

### ***Soft Switch F***

This switch is for selecting the operation frequency of the electrical system to be protected. It is crucial that the correct frequency of operation be selected and failure to do so will give rise to wrong voltage measurements.

0 – 50Hz system frequency

1 – 60Hz system frequency

# 7. Connection Diagram & Terminal Connection

## 7.1 Terminal Connection

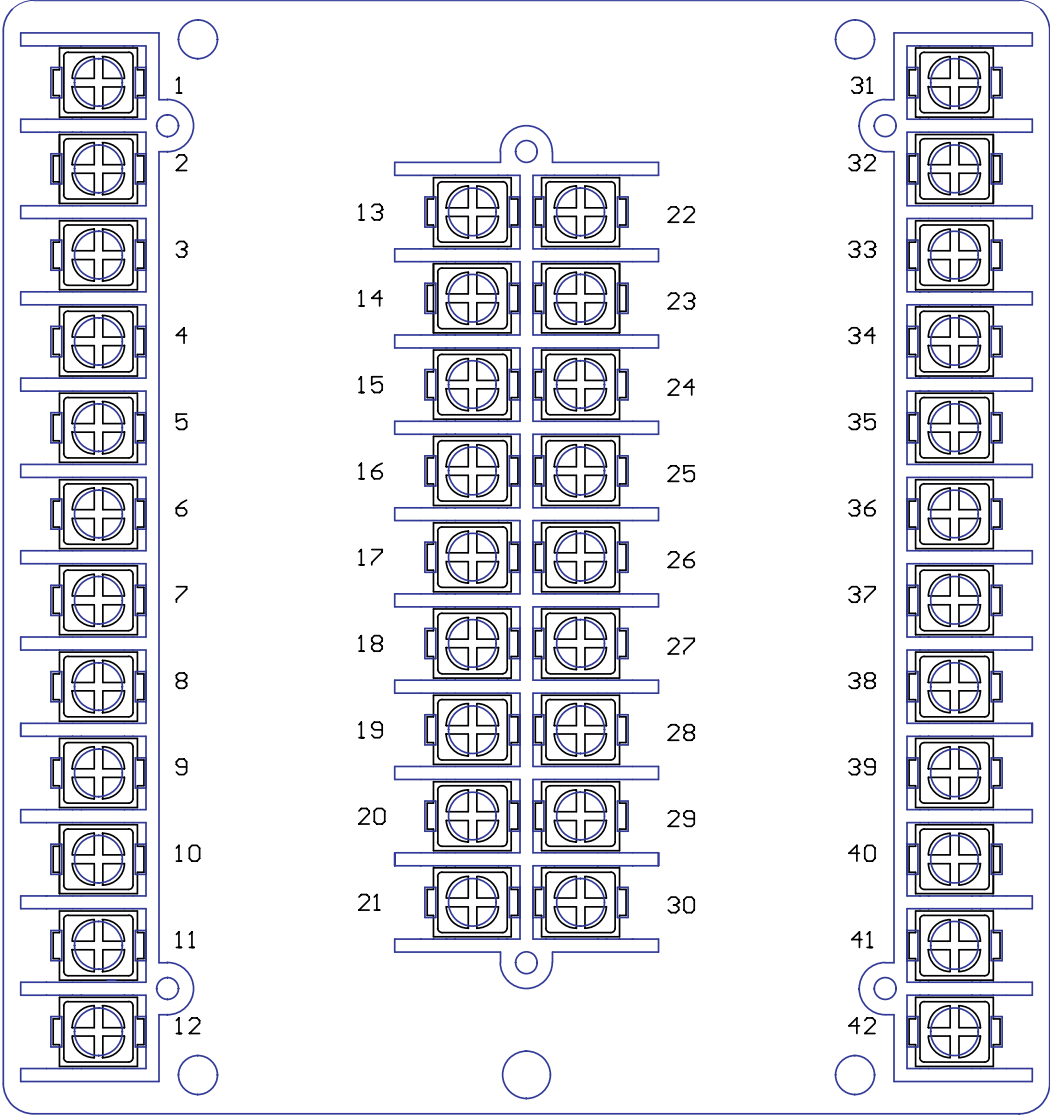

Rear view of MU2300

<b>Connection terminal</b>	<b>Description of Function</b>
1	Not used
2	VT input for phase A
3	VT input for phase A
4	Not used
5	VT input for phase B
6	VT input for phase B
7	Not used
8	VT input for phase C
9	VT input for phase C
10	Not used
11	VT input for residual voltage
12	VT input for residual voltage
13	External digital input
14	External digital input
15 to 21	Not used
22	Termination resistor (for RS485)
23	RS485 negative terminal
24	RS485 positive terminal
25	Communication cable shield
26,27	Output contact R5
28	N.C. contact for IRF
29	N.O. contact for IRF
30	COMMON contact for IRF
31	Casing earth terminal
32	Auxiliary supply input (No polarity)
33	Auxiliary supply input (No polarity)
34	N.C. contact for tripping contact R1
35	N.O. contact for tripping contact R1
36	COMMON contact for contact R1
37,38	Output contact R2
39,40	Output contact R3
41,42	Output contact R4

# Example 1: 3Vpn CONFIGURATION (Phase-Neutral)

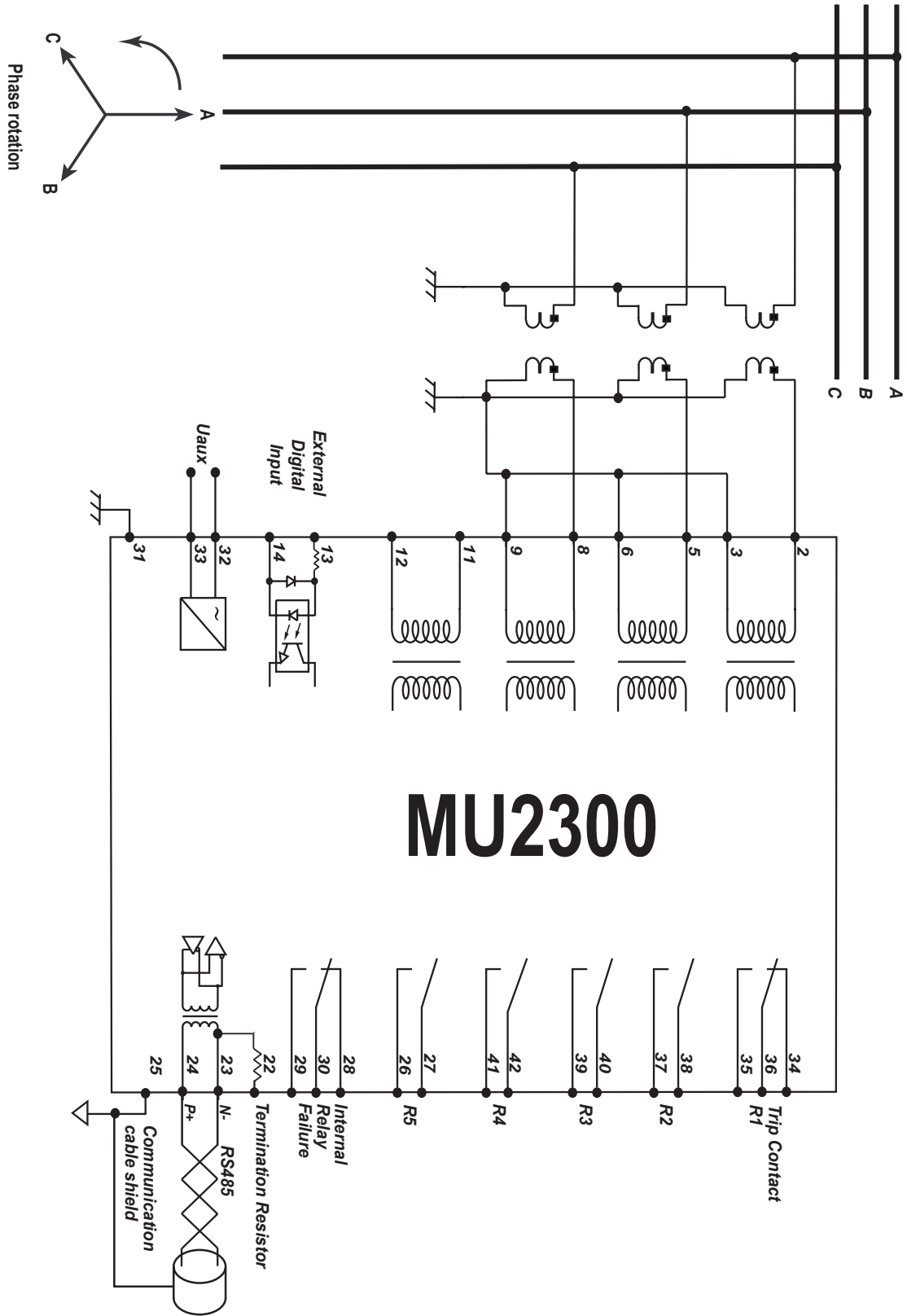

Example 2:  $3V_{pn} + V_0$  CONFIGURATION (Phase-Neutral) + residual voltage.

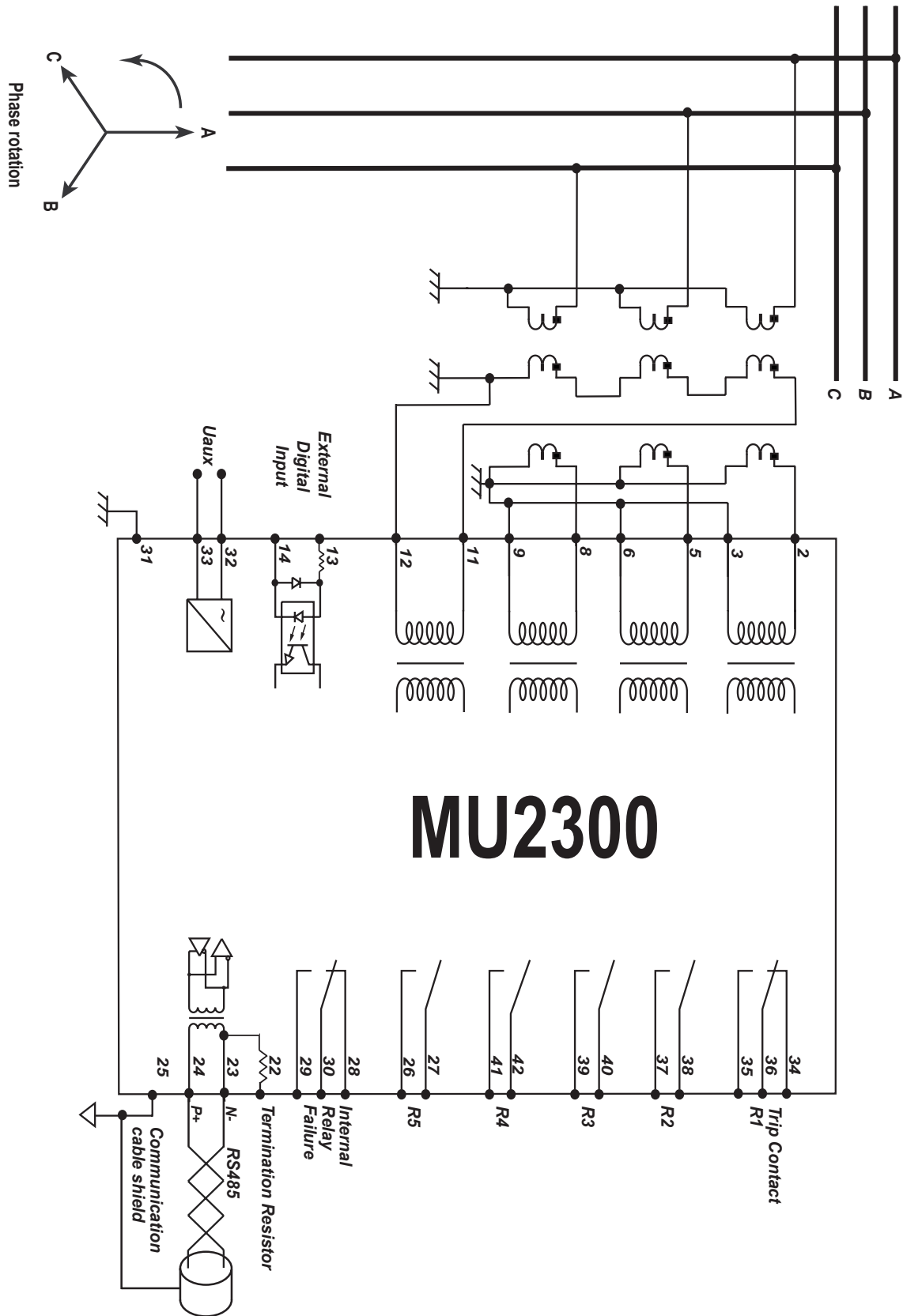



Example 3:  $3V_{pp} + V_0$  CONFIGURATION (Phase-Phase) + residual voltage.

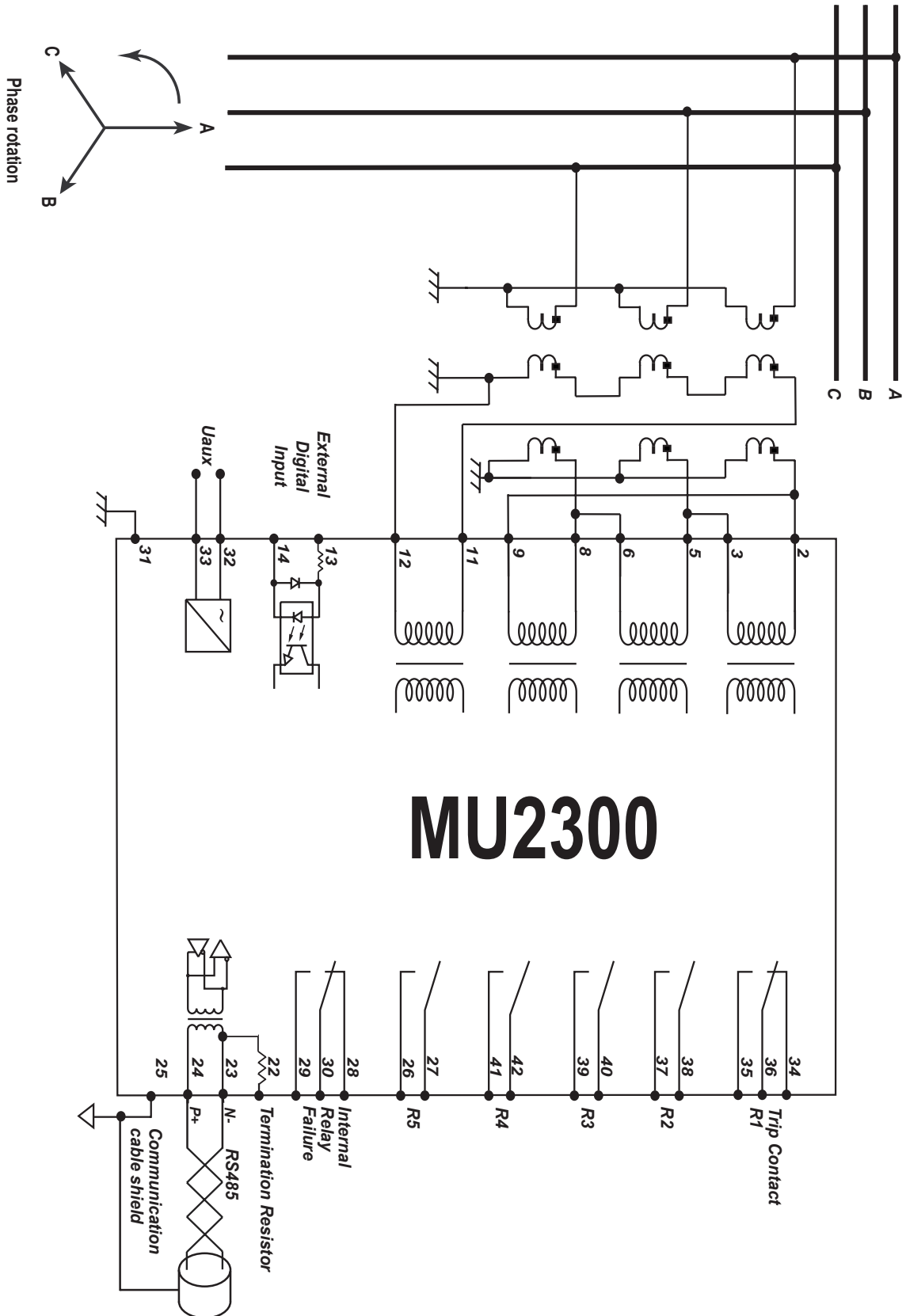

Example 4:  $2V_{pp} + V_0$  CONFIGURATION + residual voltage

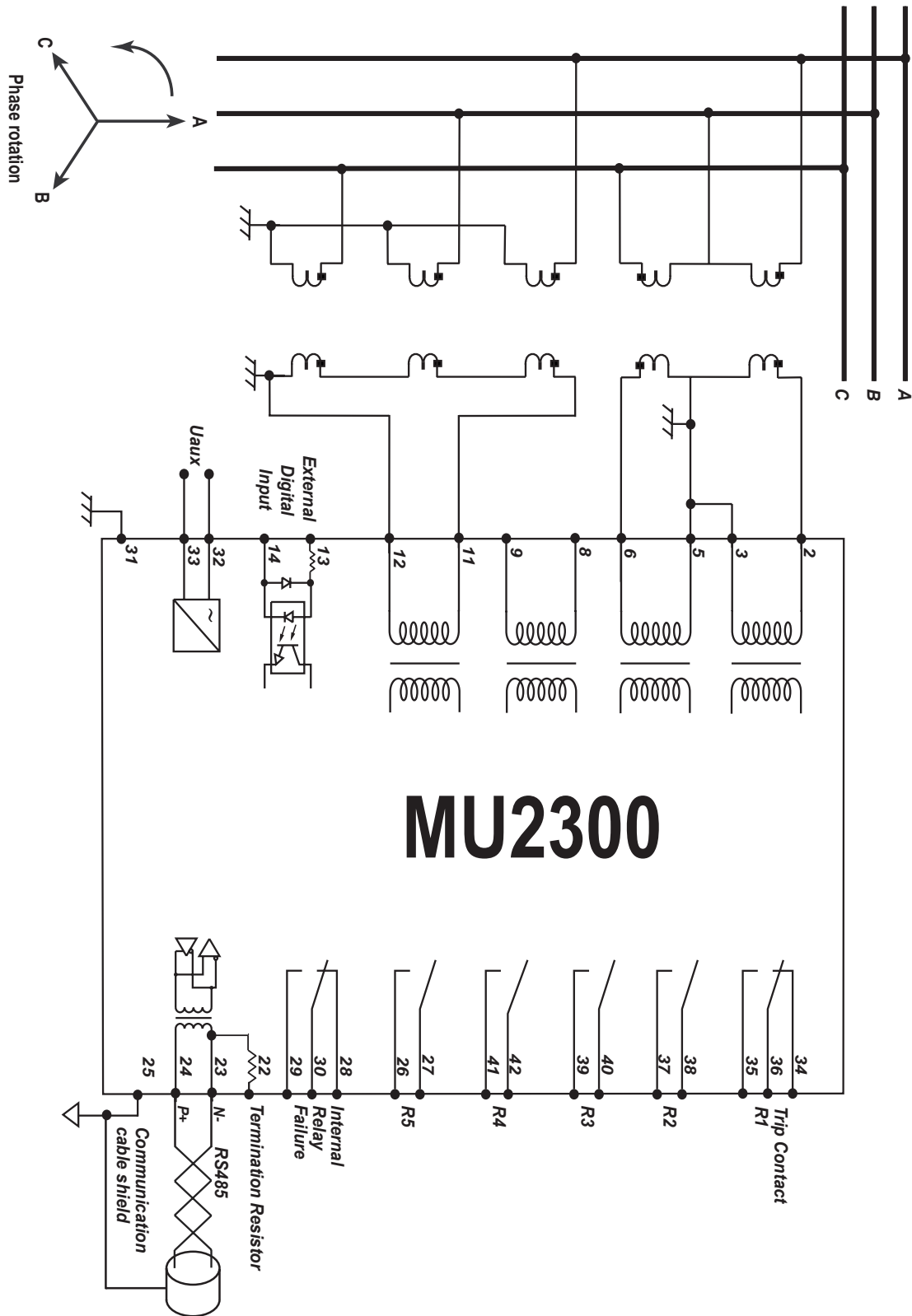

## 8. Case Dimension

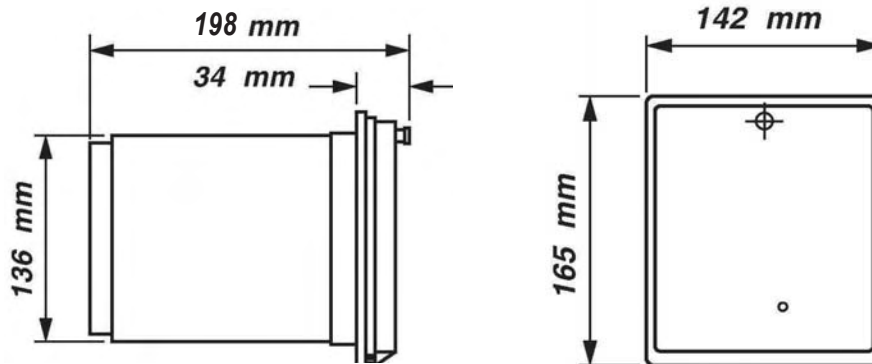
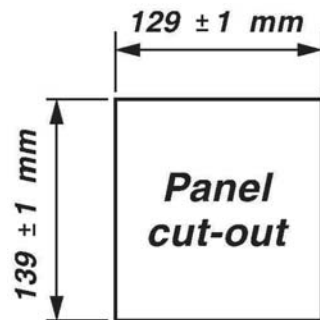

## 9. Technical Data

### Input

i)	<i>Measuring Inputs</i>	
	Rated Voltage Input *	57-130V
	Frequency	50Hz or 60Hz
ii)	<i>Rated Auxiliary supply voltage</i>	
	Model MU2300-150D	24~150V DC
	Model MU2300-240AD	85~265V AC 110~340V DC
iii)	<i>Power Consumption</i>	6-10VA typical (AC auxiliary voltage) 5-9W typical(DC auxiliary voltage)
iv)	<i>External Digital Input</i>	80~250V AC/DC

\*Maximum input voltage is 260V

### Output

i)	<i>All contacts</i>	
	Rated voltage	250V AC
	Continuous carry	5A AC or DC
	Make and carry for 0.2 sec	30A AC or DC
	Expected electrical life (min operation)	5,000,000
	Operating time	Maximum 15ms

### Undervoltage element

i)	<i>Low set</i>	
	Low set setting, $U<$	5-130V
	Low set definite time, $tU<$	0-600s
	Time multiplier, TMS	0.5-100
ii)	<i>High set</i>	
	High set setting, $U\ll$	5-130V
	High set definite time, $tU\ll$	0-600s
iii)	<i>Hysteresis</i>	105%

**Overvoltage element**

i)	<i>Low set</i>	
	Low set setting, $U_{>}$	5-200V
	Low set definite time, $tU_{>}$	0-600s
ii)	<i>High set</i>	
	High set setting, $U_{>>}$	5-260V
	High set definite time, $tU_{>>}$	0-600s
iii)	<i>Time multiplier, TMS</i>	0.5-100

**Negative sequence overvoltage element**

i)	Negative sequence overvoltage setting, $U_{2>}$	5-200V
ii)	Time multiplier, TMS	0.5-100
iii)	Negative sequence overvoltage definite time, $tU_{2>}$	0-600s

**Residual overvoltage element**

i)	Residual overvoltage setting, $U_{0>}$	0.5-130V
ii)	Time multiplier, TMS	0.5-100
iii)	Residual overvoltage definite time $tU_{0>}$	0-600s

**Communication**

i)	Hardware interface	Isolated RS485
ii)	Protocol	Modbus-RTU
iii)	Baud rate	300,600,1200,2400,4800, 9600,19200

## *10 Tests and Standards*

High voltage dielectric withstand test. IEC60255-5 .....	2.0kV rms, 1 min
High voltage impulse test. IEC60255-5 .....	5kV, 1.2/50 $\mu$ s
Electrical fast transient. IEC61000-4-4, Level 4, power supply inputs .....	4kV, 5/50ns
Electrical fast transient. IEC61000-4-4, Level 4, other inputs .....	2kV, 5/50ns
Electrostatic discharge. IEC61000-4-2 Class III, air discharge .....	8kV
Electrostatic discharge. IEC61000-4-2 Class III, contact discharge .....	6kV
Enclosure protection when panel mounted .....	IP54

## *11 Appendix A*

Binary to hexadecimal conversion table: -

Hexadecimal	Binary	Decimal
0	0000	0
1	0001	1
2	0010	2
3	0011	3
4	0100	4
5	0101	5
6	0110	6
7	0111	7
8	1000	8
9	1001	9
A	1010	10
B	1011	11
C	1100	12
D	1101	13
E	1110	14
F	1111	15

## 12 Appendix B

### Decimal to Hexadecimal Conversation

Decimal	Hexadecimal	Decimal	Hexadecimal	Decimal	Hexadecimal
1	1	44	2C	87	57
2	2	45	2D	88	58
3	3	46	2E	89	59
4	4	47	2F	90	5A
5	5	48	30	91	5B
6	6	49	31	92	5C
7	7	50	32	93	5D
8	8	51	33	94	5E
9	9	52	34	95	5F
10	A	53	35	96	60
11	B	54	36	97	61
12	C	55	37	98	62
13	D	56	38	99	63
14	E	57	39	100	64
15	F	58	3A	101	65
16	10	59	3B	102	66
17	11	60	3C	103	67
18	12	61	3D	104	68
19	13	62	3E	105	69
20	14	63	3F	106	6A
21	15	64	40	107	6B
22	16	65	41	108	6C
23	17	66	42	109	6D
24	18	67	43	110	6E
25	19	68	44	111	6F
26	1A	69	45	112	70
27	1B	70	46	113	71
28	1C	71	47	114	72
29	1D	72	48	115	73
30	1E	73	49	116	74
31	1F	74	4A	117	75
32	20	75	4B	118	76
33	21	76	4C	119	77
34	22	77	4D	120	78
35	23	78	4E	121	79
36	24	79	4F	122	7A
37	25	80	50	123	7B
38	26	81	51	124	7C
39	27	82	52	125	7D
40	28	83	53	126	7E
41	29	84	54	127	7F
42	2A	85	55		
43	2B	86	56		



## 13 Appendix C

Event code:

Event code	Description
00	U1P/U12 undervoltage U < start
01	U2P/U23 undervoltage U < start
02	U3P/U31 undervoltage U < start
03	U1P/U12 undervoltage U < trip
04	U2P/U23 undervoltage U < trip
05	U3P/U31 undervoltage U < trip
06	U1P/U12 undervoltage U << start
07	U2P/U23 undervoltage U << start
08	U3P/U31 undervoltage U << start
09	U1P/U12 undervoltage U << trip
10	U2P/U23 undervoltage U << trip
11	U3P/U31 undervoltage U << trip
40	U1P/U12 undervoltage U < start reset
41	U2P/U23 undervoltage U < start reset
42	U3P/U31 undervoltage U < start reset
43	U1P/U12 undervoltage U < trip reset
44	U2P/U23 undervoltage U < trip reset
45	U3P/U31 undervoltage U < trip reset
46	U1P/U12 undervoltage U << start reset
47	U2P/U23 undervoltage U << start reset
48	U3P/U31 undervoltage U << start reset
49	U1P/U12 undervoltage U << trip reset
50	U2P/U23 undervoltage U << trip reset
51	U3P/U31 undervoltage U << trip reset
12	U1P/U12 overvoltage U > start
13	U2P/U23 overvoltage U > start
14	U3P/U31 overvoltage U > start
15	U1P/U12 overvoltage U > trip
16	U2P/U23 overvoltage U > trip
17	U3P/U31 overvoltage U > trip
18	U1P/U12 overvoltage U >> start

19	U2P/U23 overvoltage U >> start
20	U3P/U31 overvoltage U >> start
21	U1P/U12 overvoltage U >> trip
22	U2P/U23 overvoltage U >> trip
23	U3P/U31 overvoltage U >> trip
52	U1P/U12 overvoltage U > start reset
53	U2P/U23 overvoltage U > start reset
54	U3P/U31 overvoltage U > start reset
55	U1P/U12 overvoltage U > trip reset
56	U2P/U23 overvoltage U > trip reset
57	U3P/U31 overvoltage U > trip reset
58	U1P/U12 overvoltage U >> start reset
59	U2P/U23 overvoltage U >> start reset
60	U3P/U31 overvoltage U >> start reset
61	U1P/U12 overvoltage U >> trip reset
62	U2P/U23 overvoltage U >> trip reset
63	U3P/U31 overvoltage U >> trip reset
24	Negative sequence overvoltage $U_2 >$ start
25	Negative sequence overvoltage $U_2 >$ trip
64	Negative sequence overvoltage $U_2 >$ start reset
65	Negative sequence overvoltage $U_2 >$ trip reset
26	Residual overvoltage $U_0 >$ start
27	Residual overvoltage $U_0 >$ trip
66	Residual overvoltage $U_0 >$ start reset
67	Residual overvoltage $U_0 >$ trip reset
A0	R1 activated
A1	R1 reset
A2	R2 activated
A3	R2 reset
A4	R3 activated
A5	R3 reset
A6	R4 activated
A7	R4 reset

A8	R5 activated
A9	R5 reset
B1	Digital input activated
B2	Digital input reset
E1	Tripped by external digital input
FE	Relay is powered up



**INDUSTRI TEKNOLOGI MIKRO BERHAD,**

No. 1, Jalan TP 7/7, Sime UEP Industrial Park, 40400 Shah Alam, Selangor, Malaysia.

Tel: +603-5192 7155 Fax: +603-5192 7166 Website: [www.itmikro.com](http://www.itmikro.com)

E-mail: [sales@itmikro.com](mailto:sales@itmikro.com)

**MU2300-150806**